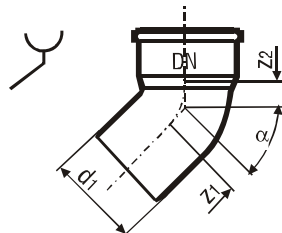
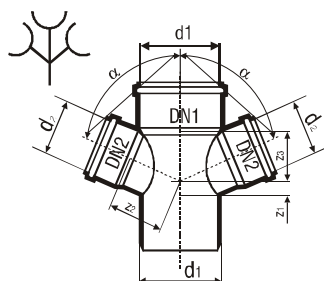

БДС EN 1451

ДЪГА
BEND

Ном. No Nom. No	DN	d ₁ mm	z ₁ mm	z ₂ mm	Брой в кашон Pieces in a box
S 20; α=45°					
09210012	50	50	13	19	180 C
09210052	100	110	25	31	25 C
S 20; α=87,5°					
09210022	50	50	31	37	150 C
09210062	100	110	60	66	20 C

РАЗКЛОНИТЕЛ ДВОЕН
DOUBLE PIPE BRANCH

Ном. No Nom. No	DN1	d ₁ mm	DN2	d ₂ mm	z ₁ mm	z ₂ mm	z ₃ mm	Брой в кашон Pieces in a box
S 20; α=45°								
09230112	100	100	70	75	1	116	108	
09230212	100	110	100	110	25	133	133	



РАЗКЛОНИТЕЛ ЕДИНИЧЕН
SINGLE PIPE BRANCH

БДС EN 1451

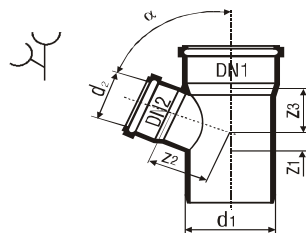

Ном. No Nom. No	DN1	d ₁ mm	DN2	d ₂ mm	z ₁ mm	z ₂ mm	z ₃ mm	Брой в кашон Pieces in a box
S 20; α=45°								
09220012	50	50	50	50	12	61	61	80 C
09220112	70	75	50	50	-1	79	74	
09220322	100	110	50	50	-17	103	91	
09220342	100	110	70	75	1	116	109	
09220362	100	110	100	110	25	134	134	
S 20; α=67,5°								
09220382	100	110	100	110	40	86	86	
S 20; α=87,5°								
09220022	50	50	50	50	28	30	30	80 C
09220122	70	75	50	50	27	43	31	
09220332	100	110	50	50	28	60	32	32 C
09220352	100	110	70	75	40	60	45	
09220372	100	110	100	110	57	62	62	15 C



ПРЕХОД
SOCKET CONNECTING PIPE

БДС EN 1451

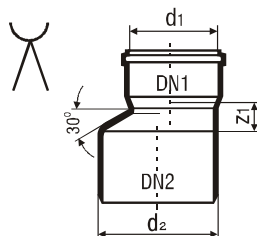

Ном. No Nom. No	DN1	d ₁ mm	DN2	d ₂ mm	z ₁ mm	Брой в кашон Pieces in a box
S 20						
09250012	50	50	70	75	22	100 C
09250032	50	50	100	110	43	40 C
09250042	70	75	100	110	28	40 C
09250062	100	110	150	160	34	
S 16						
09250072	150	160	200	200	36	

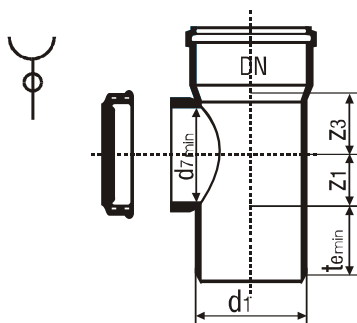
ТРЪБА КОНТРОЛНА
CONTROL PIPE

Ном. No Nom. No	DN1	d ₁ mm	t _{e, min} mm	d _{7, min} mm	Z ₁ mm	Z ₃ mm	Брой в кашон Pieces in a box
09240012	50	50	48	46	28	30	
09240022	70	75	51	70	40	43	35 C
09240032	100	110	58	98	57	62	15 C



МУФА ДВОЙНОПРОХОДНА
TWO WAY PIPE SOCKET

БДС EN 1451

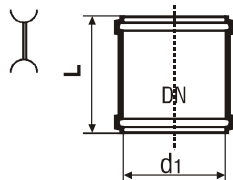

Ном. No Nom. No	DN	d_1 mm	L_{min} mm	Брой в кашон Pieces in a box
09250312	50	50	103	
09250332	100	110	125	

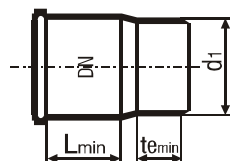
МУФА КОМПЕНСАЦИОННА
COMPENSATING SOCKET

Ном. No Nom. No	DN	d_1 mm	$t_{e,min}$ mm	L_{min} mm	Брой в кашон Pieces in a box
09250612	100	110	58	60	18C

